



CONTOIL®

VZO / VZOA, DN 15 – 50

Table of Contents

- 1 Safety.....2**
- 1.1 Intended Use 2
- 1.2 Notes on safety rules and symbols..... 2
- 1.3 Safety rules and precautions 3
- 1.4 About the operating manual..... 3
- 2 Product description 4**
- 2.1 Flow meter configuration 4
- 3 Scope of delivery an accessories 5**
- 4 Mounting 6**
- 4.1 Mechanical installation..... 11
- 4.2 Electrical Installation..... 13
- 4.3 Engineering notes 14
- 5 Installation 15**
- 6 Maintenance and Repair 16**
- 6.1 Calibration..... 16
- 6.2 Service maintenance..... 16
- 6.3 Maintenance..... 17
- 6.4 Spare parts 19
- 7 Troubleshooting.....20**
- 8 Decommissioning, Dismantling and Disposal22**
- 8.1 Decommissioning.....22
- 8.2 Dismantling.....22
- 8.3 Return of materials.....22
- 8.4 Disposal.....23
- 9 Technical data24**
- 9.1 Hardware characteristics.....24
- 10 Appendix.....24**
- 10.1 Dimensional drawings26
- 10.2 Dimensions of display and pulse units.....27
- 11 Certificates28**

1 Safety

1.1 Intended Use

The device CONTOIL[®] fuel oil meter is designed and solely intended for the flow measurement of Diesel oil to Heavy Fuel Oil according to ISO 8217-2010.

Improper or non-intended use of the device may compromise operational reliability of the device. The manufacturer accepts no liability for any resulting personal injury or material damage.

1.2 Notes on safety rules and symbols

The devices are designed to meet the latest safety requirements. They were tested and delivered in a condition that ensures safe operation. Improper or non-intended use of the devices can, however, be dangerous. Therefore, pay particular attention to the safety instructions within this manual, which are always shown by the following symbols:



WARNING

WARNING indicates a hazardous situation which, if not avoided, could result in death or serious injury.



CAUTION

CAUTION indicates a hazardous situation which, if not avoided, could result in minor or moderate injury.



NOTICE

NOTICE indicates a hazardous situation which, if not avoided, could result in property damage.



NOTE

NOTE indicates helpful tips and recommendations, as well as information for efficient and trouble-free operation.



See technical brochure or
mounting and operating manual
QR code link to our download website



1.3 Safety rules and precautions

The manufacturer accepts no responsibility if the following safety rules and precautions are disregarded:

- » Any modifications of the device implemented without the prior written consent of the manufacturer will result in the immediate termination of product liability and warranty.
- » Installation, operation, maintenance and decommissioning of this device must be carried out by trained, qualified specialists, authorized by the manufacturer, operator or owner of the facility. The specialist must have read and understood this entire installation and operating manual and must follow the instructions contained herein.
- » Check the mains voltage and the information on the type plate before installing the device.
- » Check all connections, settings and technical specifications of any peripheral devices.
- » Open housing or parts of housing containing electric or electronic components only when the electric power is turned off.
- » Do not touch any electronic components (ESD sensitivity).
- » Never exceed the specified classifications for mechanical load (e. g. pressure, temperature, ingress protection (IP) etc.).
- » Release the pressure in the pipe system and reduce the temperature of the medium to a safe level for humans when carrying out any work involving the system's mechanical components.
- » None of the information contained in this manual or in any other documents shall release planners, engineers, installers and operators from their own careful and comprehensive assessment of the respective system configuration in terms of functional capability and operational safety.
- » The local labor and safety laws and regulations must be adhered to.

1.4 About the operating manual

The manufacturer reserves the right to make changes to technical data without prior notice. The latest information and versions of this operating manual can be requested from your local dealer.



WARNING

The manufacturer assumes no liability if the instructions and procedures described in this manual are not followed!



NOTICE

This installation manual is intended for qualified personnel and therefore does not include basic working steps. Before operating the equipment or system, this installation and operating manual must be completely read and understood. Please retain this manual for future reference!

2 Product description

Thank you for purchasing this high-quality Product.

2.1 Flow meter configuration

The CONTOIL® flow meters consist of a hydraulic part, a coupling and an mechanical counter.

The hydraulic part determines the nominal size of the flow meter.

The flow meters are calibrated before they leave the factory. Nevertheless, for optimal results of differential measurement, flow meters of VZOA with special calibration (pairing) should be used.

Mechanical counter VZO / VZOA

Local mechanical display with or without pulse output.

Display units

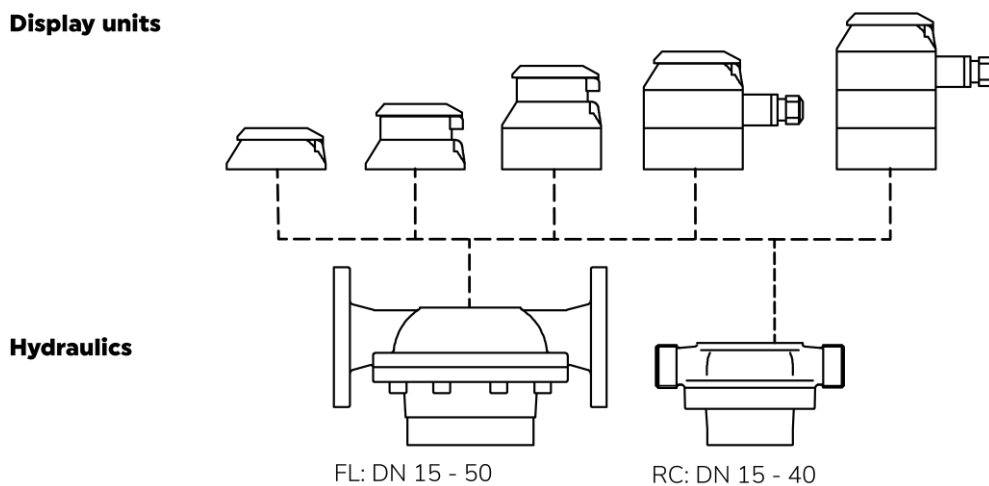

For details, see the dimensional drawings in Appendix, chapter 10.1 on page 26.

3 Scope of delivery an accessories

The scope of delivery is described on the delivery note. Please check all components and parts delivered promptly after receipt of goods. Transport damages shall be reported immediately on receipt of the goods.

- » 1 Flow meter with mechanical counter
- » 1 Mounting and operating instruction

4 Mounting

CAUTION

The surfaces of the device and the medium may be hot.



Risk of burns!

- » Carry out work only on cooled systems.
- » Work may only be performed by authorized specialists in accordance with the applicable regulations.
- » Use appropriate protective equipment.

WARNING

The pipe and the device may be under pressure.



Risk of severe injury!

- » Carry out work only on non-pressurized systems.
- » When working on the device watch out for leaking medium.
- » Work may only be performed by authorized specialists in accordance with the applicable regulations.
- » Use appropriate protective equipment, particularly safety goggles.

Flow meter installation

Easy access for reading the flow meter and controlling the ancillary equipment is important.

Provided that the arrow on the housing is in the direction of flow, the flow meter can be installed in any position without any special modifications.

The mechanical counter can be turned to the desired position.

Exception: upside down installation.

Flow conditioners are unnecessary.

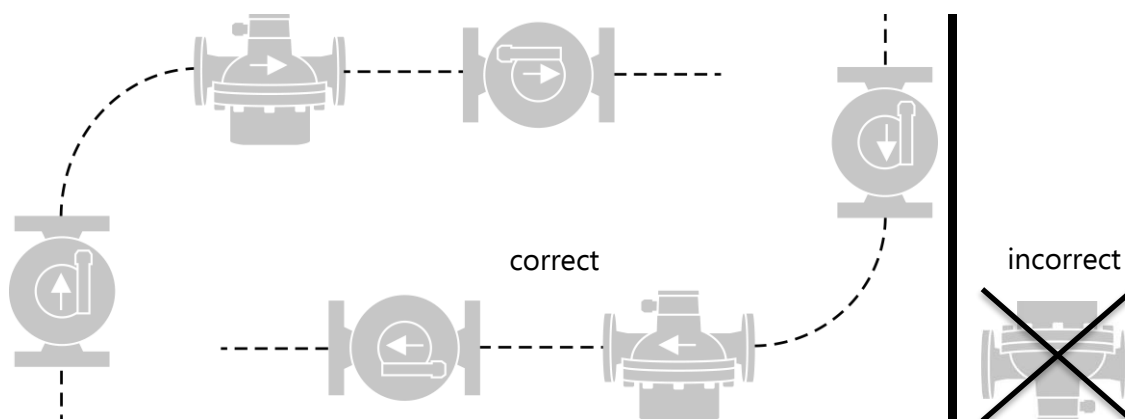



NOTE

The layout of piping must ensure that the flow meter is filled with liquid at all times and that no inclusions of air, foam or gas may occur.

Aquametro Oil & Marine recommends to install bypass valves.

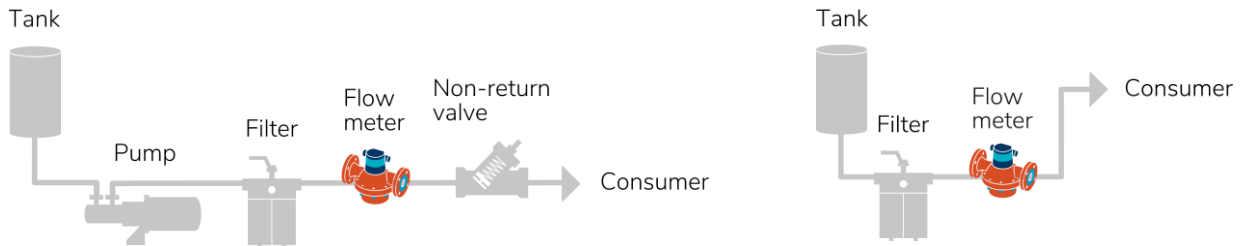

The quantities from all consumers must be registered by the flow meter.

Correct layout of flow meter and accessories

If the flow meter is used for viscosities higher than 5 mPas, or if it is mounted on the suction side of a pump, the pressure loss and the flow rate that can still be attained should be determined with the help of the pressure loss curves provided in CONTOIL® Technical Information. In addition, the pressure loss due to installed filters must be taken into consideration.

Select the flow meter and ancillaries according to the working conditions listed below:

- » Flow meters must be selected according to the maximum flow rate and not according to the pipe diameter. If necessary, adjust the pipeline.
- » Flow rate (maximum expected application flow rate = maximum-continuous flow rate of flow meter Q_{cont})
- » Material compatibility with medium
- » Operating pressure and temperature
- » Ambient temperature

Non-Return-Valves

In order to avoid backflow and draining, Non-Return-Valves must be mounted after the flow meter. Backflow and draining can cause faulty measurements and may damage the flow meter.

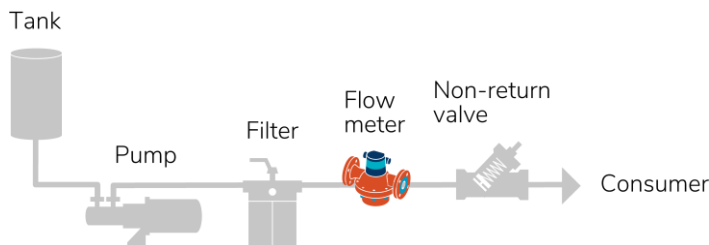

Pressure shocks during operation with the flow meter must be avoided.

Dirt filter, Safety filter

Filters should be fitted to prevent any damage to the flow meter from impurities in the oil.

Maximum mesh width for filters

Nominal size	Flow meter type	
	VZO	VZOA
DN 15	0.250 mm	0.100 mm
DN 20	0.400 mm	0.100 mm
DN 25	0.400 mm	0.250 mm
DN 40	0.600 mm	0.250 mm
DN 50	0.600 mm	0.250 mm

NOTICE

The filter mounted in the flow meter inlet is only a safety filter and cannot act as a dirt filter.



Risk of malfunction or damage.

If the medium contains dirt always have a dirt filter installed upstream of the flow meter.

Heat insulation

The display unit shall not be insulated. This could cause its permitted temperature range to be exceeded.

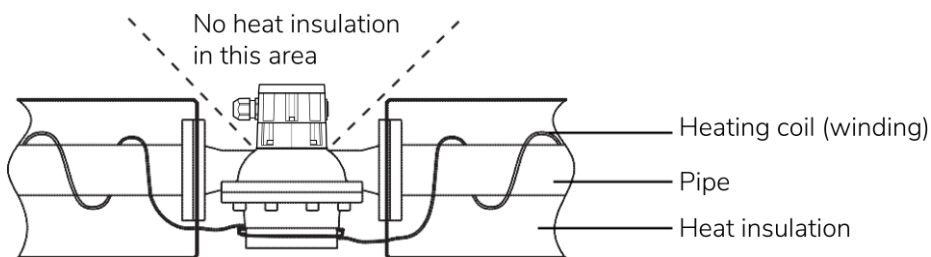

The permitted temperature ranges for the flow meter must be observed!

Special requirements - differential measurements

For differential measurements, one flow meter is installed in the supply line pipe and one in the return line pipe. The flow difference between these meters determines the consumption. If ordered with the "differential measurement" option, VZOA flow meters are calibrated in accordance with the indicated supply and return flow volumes. The flow meters are labeled "SUPPLY" (0) and "RETURN" (1). Make sure that these flow meters are installed in the correct pipeline, i.e. the supply flow meter shall be installed in the supply line pipe and the return flow meter shall be installed in the return line pipe.

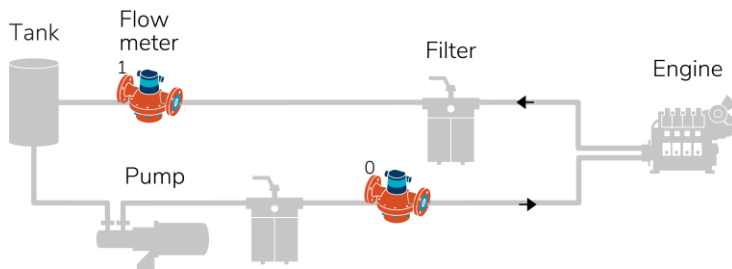

Special requirements - ships

On ships, attention is required to ensure that the engine can continue to operate at full power even if there is heavy filter contamination or if the flow meter is damaged. A pressure switch can be used to switch over to the bypass and to draw attention for servicing. The engine then continues to operate but without consumption measurements.

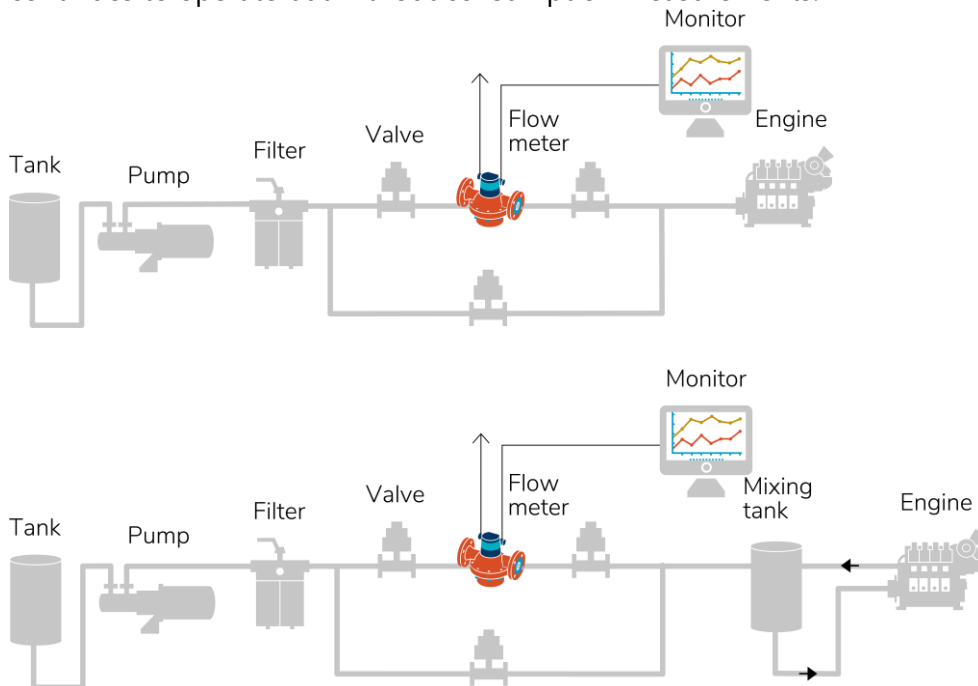

Ship classification societies require the installation of bypass pipes. The relevant regulations must be followed.

Installation of the flow meter on the suction side of a pump

If the flow meter is installed on the suction side of a pump, consideration must be given to avoid air-intake or foam.

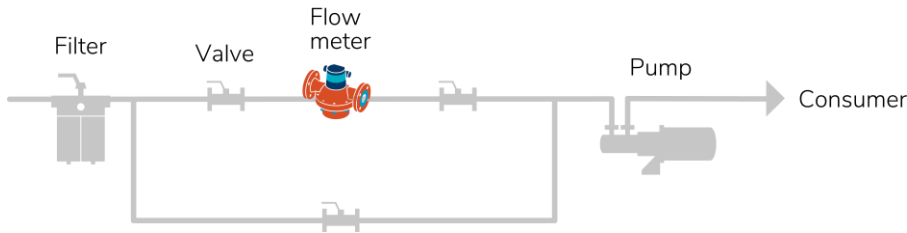

Installation of the flow meter on the pressure side of a pump

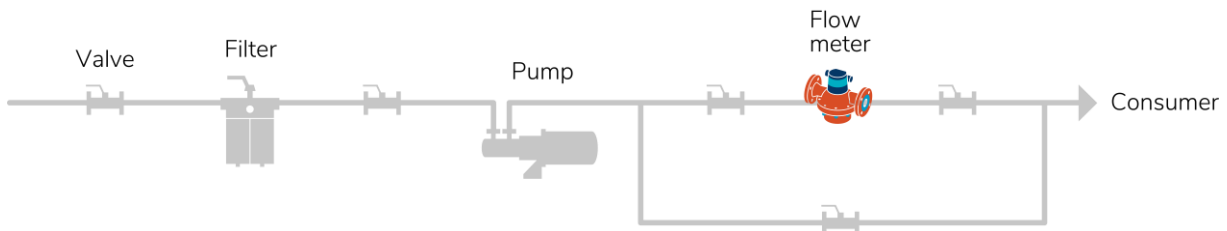

Special requirements - filling and dosing units

For filling and dosing, the valve must be fitted between flow meter and discharge. The shorter the pipe section between valve and discharge, the higher the accuracy. Avoid water hammer if fast closing valve is installed.

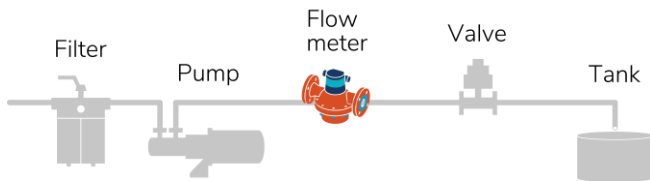

Flushing of pipes

If the pipes are to be flushed at a later stage, stop valves shall be provided on both sides of the flow meter.



NOTICE

Accumulation of debris will occur in front of the stop-valve during flushing. To eliminate this, replace the flow meter with a spool piece.

Flushing

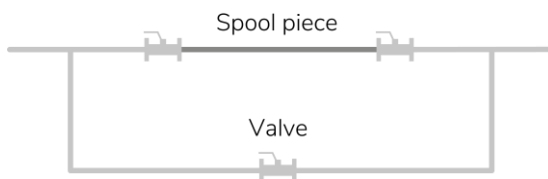

Measuring

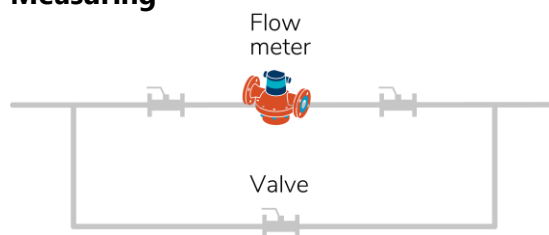

4.1 Mechanical installation

WARNING

Leakage or rupture due to connections being made using force.



Risk of severe injury!
Risk of substantial property damage!

- » Never attempt to overcome misalignments (lateral, angular, longitudinal, torsional) using force.
- » Make sure the pipings are flexible enough, if not: use compensators.
- » Consider the effects of thermal contraction and expansion.

WARNING

Leakage or rupture due to misuse of the mounting material.



Risk of severe injury!
Risk of substantial property damage!

- » Regarding mechanical strength, with bolts, screws and nuts, use the prescribed dimensions.
- » Use the full number of bolts, screws and nuts.
- » Observe the prescribed thread lubrication (grease or dry!).
- » Tighten the bolts and nuts in the proper sequence to the specified torque.

If using flanged connections, the correct number of connector elements must be fitted and they must be tightened with the correct torque in accordance with the screw manufacturer's instructions. Comply with the permissible operating data as defined on the type plate. Make sure that no hazardous fumes can build up in the piping and in the flow meter during commissioning, decommissioning and dismantling. The flow meter must at all times be completely filled with liquid during operation. Check the flow meter periodically for tightness of the connections and for proper functioning. If work is to be done on the installation, before each intervention: release the pressure in the installation if hazardous liquids are used, wear protective clothing and safety goggles, place a collecting tray underneath the installation.

Preparing for installation

Check flow meters and installation material.

Compare the data of the flow meter name plate with the expected maximum conditions of the installation. They may not exceed the flow meter specifications:

- » Continuous flow rate (Q_{cont} l/h)
- » Maximum operating pressure (PN bar)
- » Maximum temperature ($^{\circ}C$)
- » Appropriate connections (threaded, or flanged) and seals (gaskets)
- » Fasteners for the flow meter
- » Resistance to liquid to be metered and temperature

CAUTION

Unauthorized start-up while mounting



Risk of injury!

- » Make sure that unauthorized start-up is not possible while mounting.
- » Comply with the applicable working regulations during all work on the system.

NOTE



When existing systems are altered:
Take the flow meter out of operation in order to flush the system clean of debris.
Flushing information on page 10.

Trial operation

Start trial operation (without flow meter); open the stop valves **slowly** when doing this.

- » Carry out a pressure test in the plant.
- » Check for leaks and tightness of all bolts.
- » Flush the pipework until clean (flow meter out of pipeline).
- » Release the pressure and stop the system again.

This trial operation ensures that the pipework is tight and clean and that there are no foreign bodies in the pipe that could damage the flowmeter.

Installing the meter in the pipe

Remove the protection plugs or caps from the flow meter (inlet and outlet).

Insert the flow meter into the pipeline in the prescribed position and flow direction. The arrow on the flow meter should correspond with the direction of flow. Install mating flanges parallel and without tension in the pipe.

NOTICE

Mechanical connection of flow meter into the pipe systems.



Risk of leakage!

Always use appropriate sealing material as per connection type.

Meter with flanged ends

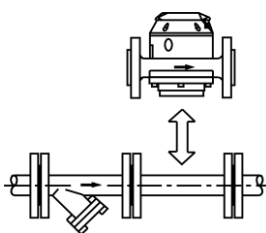

Meter with threaded ends

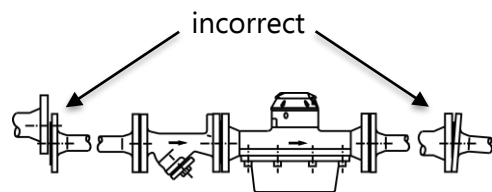
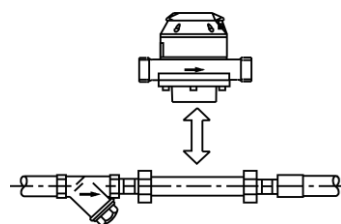

For pipes made of copper or thin-walled steel pipes, the flow meter requires additional fastening. Use appropriate fasteners.

4.2 Electrical Installation

NOTICE



Electrical connection to the supply voltage and/or connections to other systems.

Risk of malfunction or damage!

Review of technical data, chapter 9, on page 24.

Electrical connection - Display unit options VZO, VZOA

Pulser RV

Cable; 3 m, Polarity: in any order

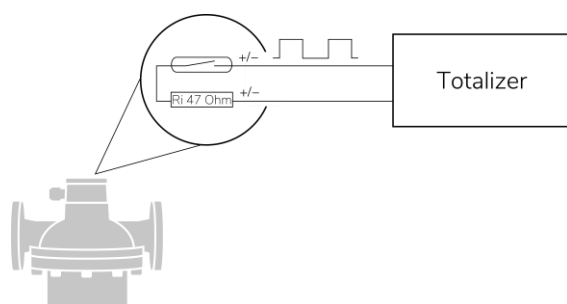

» Pulse value see type plate

Pulser IN / INA

Pay attention to polarity when connecting the plug.

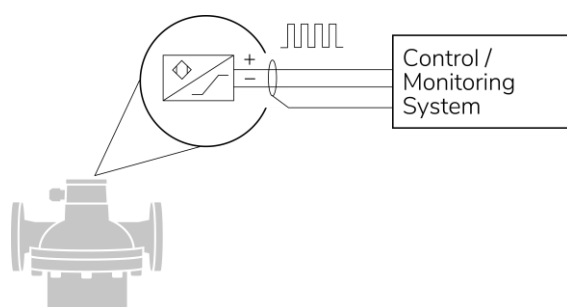

- » Pulse value see type plate
- » Connection cable min. $2 \times 0.35 \text{ mm}^2$ and 4 - 6 mm external cable diameter on plug supplied with product or use optional Art. No. 80019 with prefabricated cable
- » Connection detail can be found on cable mount instruction delivered with the product.



See mounting instructions «Cable mounting IN» (Art. No. 20259).

4.3 Engineering notes

Parameterizing ancillary devices

Some ancillary units require programming of pulse values or frequency (see the relevant operating instructions). Pulse values of the VZO(A) flow meters can be taken of the type plate. The maximum frequency is calculated with the following formula:

$$\frac{\text{max. flow rate in liters/hour}}{\text{pulse value in liters} \times 3600} = \text{frequency in Hz}$$

5 Installation



NOTE

Modification of operation settings may result in faulty or wrong measuring results.

Startup and commissioning of mechanical part of flow meter (VZO, VZOA). Open valves slowly, fill pipework gradually. Vent the installation well.

Water hammer must be avoided in order not to damage the flow meter. Inclusions of air cause measuring errors in all types of flow meter and can damage them during operation.

Check the tightness of the connections watch for leakages. Check if the flow rate of the installation correspond to the specification of the flow meter.

Roller counter type flow meter (VZO and VZOA): measure the flow volume for 30 - 60 seconds, the flow rate is calculated using the following formula:

$$\frac{\text{totalised volume in liters} \times 3600}{\text{measured time in seconds}} = \text{liters per hour}$$

Should the established flow rate be greater than the specification of the flow meter (Qcont), either a flow control valve (throttle) must be inserted behind the flow sensor or a larger size flow meter must be used.

For RV and IN(A) pulse sensors: Check function of connected accessories.

6 Maintenance and Repair

6.1 Calibration

All our flow meters are calibrated in the factory.

All our flow meters are calibrated in the factory. An accuracy check and recalibration is offered at Aquametro Oil & Marine, this is usually dependent on customer, operator or regulation requirements. This interval depends largely on the operating conditions, process liquid and the application the flow meter is installed in.

6.2 Service maintenance

CAUTION

The surfaces of the device/system and the medium may be hot.



Risk of burns!

- » Carry out work only on cooled devices/systems.
- » Work may only be performed by authorized specialists in accordance with the applicable regulations.
- » Use appropriate protective equipment.

WARNING

The device/system may be under pressure.



Risk of severe injury!

- » Carry out work only on non-pressurized systems.
- » When working on the device/system watch out for leaking medium.
- » Work may only be performed by authorized specialists in accordance with the applicable regulations.
- » Use appropriate protective equipment, particularly safety goggles.

NOTICE

Use of unsuitable cleaning agents and procedures.



Risk of malfunction or damage!

Follow the cleaning instructions on the next page.

NOTICE

Warranty will be void, if the flow meter is being opened during the warranty period by a non Aquametro Oil & Marine certified person.



Before working on the hydraulics:

- » put the system or section out of operation
- » close the stop valves
- » release the pressure
- » put a suitable tray underneath the connection to be worked on
- » be prepared for spillage, have absorbent at hand

Cleaning of flow meter:

- » do not use any aggressive solvents
- » rinse hydraulic part of flow meter thoroughly

Aquametro Oil & Marine recommends to use the following cleaning solvents:

- » Gasoline used for cleaning purposes
- » Cleaner's naphtha
- » Petroleum ether

Dirt filter (not safety filter of flow meter):

- » Dirt filters must be cleaned periodically, initially at short intervals to keep fuel system free of dirt and debris.

To restart the system:

- » slowly open the stop valves, avoiding pressure surges ("water hammer")
- » vent the pipe well
- » check tightness

6.3 Maintenance**NOTICE**

Warranty will be void, if the flow meter is being opened during the warranty period by a non Aquametro Oil & Marine certified person.

Check connections periodically for tightness and if necessary retighten. For control and cleaning, the measuring chamber and the ring piston of the flow meters CONTOIL® DN 15 - 50 can be removed without dismantling the flow meter from the pipe.

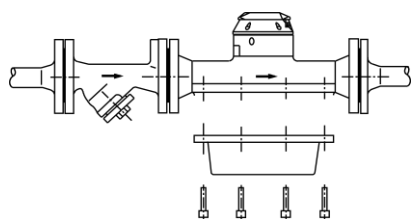

Torque of measuring chamber screws

Flow meter	Screws	Torque
DN 15, 20	M 6	6 Nm
DN 25	M 8	16 Nm
DN 40	M 12	47 Nm
DN 50	M 16	100 Nm

The cleaning and revision cycle depends largely on the conditions of operation. Under favourable conditions 5 - 10 years suffice. Check the devices for corrosion.

Recommended revision cycle

Flow meter	Totalizer volume	Time
DN 15	20'000 m ³	7 years
DN 20	50'000 m ³	7 years
DN 25	100'000 m ³	7 years
DN 40	300'000 m ³	7 years
DN 50	1'000'000 m ³	7 years

The responsibility of the revision cycles lies with the operator.

NOTICE

If opening is necessary:

Risk of malfunction!



- » Observe positions during disassembly
- » Follow assembly instructions
- » Check proper function at start up
- » Recalibration is recommended after service
- » For more information about maintenance, see Spare part list and Maintenance instructions.

Opening and closing

For instruction on opening and closing the flow meter please refer to separate manual.



See Spare part list and Maintenance instructions.

6.4 Spare parts

NOTICE



Use of wrong spare parts

Risk of malfunction or damage!

Use only original spare parts, supplied by Aquametro Oil & Marine.



Spare part list and Maintenance instructions may be requested from Aquametro Oil & Marine.

7 Troubleshooting

Fault symptoms	Possible causes	Procedures ¹⁾
» Pointers on roller counter rotate irregularly	» This is normal at high flow rates and has no effect on accuracy of measurement	» No action required
» Counter runs backwards	» Meter mounted in wrong direction	» Install meter with arrow pointing in flow direction
» Counter not running » Indicated quantity or flow rate too small	» Flow rate outside allowed range (below Q _{min} or above Q _{max} of meter)	» Check flow rate » If too high, reduce flow or install larger meter » If too low, increase flow or install smaller meter
	» Moving parts heavily worn out due to continuous overload	» Install larger meter
	» Dirt trap / filter heavily soiled	» Clean dirt trap, replace filter
	» Safety filter in meter intake clogged	» Replace safety filter » Install dirt trap / filter with correct mesh size
	» Moving parts jammed	» Clean measuring chamber, replace defective parts
	» Alignment of inner parts	» Align cover and measuring chamber (rip to rip)
	» Separating plate broken by - Pressure hammer - Gas inclusions	» Check and rectify operating conditions and meter position » Fill pipes slowly De-aerate pipes thoroughly
» Indicated quantity or flow rate too high	» Meter positioned wrongly (e.g. at highest point) » Gas or air inclusion in fluid	» Check and rectify operating conditions and meter position » De-aerate pipes carefully
» Pressure drop at meter too high	» Dirt trap or filter heavily soiled	» Clean dirt trap, replace filter
	» Flow meter's safety filter heavily soiled	» Clean safety filter of flow meter

» No pulse output signal	» No flow	» Check flow using Indication
	» Pulser sensor defective ²⁾	» Replace sensor
	» Pulser module defective ²⁾	» Remove sensor and check if pulser disk does rotate
	» Pulser disk does not rotate ²⁾	» Remove pulser module, place counter on first module, and check flow indication
		» If indication is positive, replace pulser module otherwise see "Counter not running"
» Reed pulser defective ³⁾	» Replace roller counter	

1) Consult operating instructions

2) Pulse type IN / INA only

3) Pulse type RV only

8 Decommissioning, Dismantling and Disposal

CAUTION

The surfaces of the device/system and the medium may be hot.



Risk of burns!

- » Carry out work only on cooled devices/systems.
- » Work may only be performed by authorized specialists in accordance with the applicable regulations.
- » Use appropriate protective equipment.

WARNING

The device/system may be under pressure.



Risk of severe injury!

- » Carry out work only on non-pressurized devices/systems.
- » When working on the device/system watch out for leaking medium.
- » Work may only be performed by authorized specialists in accordance with the applicable regulations.
- » Use appropriate protective equipment, particularly safety goggles.

8.1 Decommissioning

Disconnect all sources of energy.

Remove the flow meter from system.

8.2 Dismantling

Not required.

8.3 Return of materials

Never send a device/system back if you are not absolutely certain that all traces of hazardous substances have been removed, e.g. substances which have penetrated crevices or diffused through plastic.

Costs incurred for waste disposal and injury (burns, etc.) due to inadequate declaration and/or cleaning will be charged to the delivering company or the operator.

For a device that is sent back to Aquametro Oil & Marine for repair or calibration the following point are an absolute must:

- » Always quote type and serial number when contacting an Aquametro Oil & Marine office or an Aquametro representative.
- » Always enclose a duly completed "Declaration of decontamination" form (FO0451e).
- » Only in special cases (e.g. for the reconstruction of causes of errors) and only with the prior consent of the Aquametro Oil & Marine, equipment must be returned in the unpurified state. In this case also the contact person at Aquametro Oil & Marine, which has granted the approval to return a crude device must be stated.



Use form
«FO0451e_Declaration of Decontamination» and
«FO0301e_Return Form».

8.4 Disposal



At the end of its life cycle, this product should be disposed of according to local regulations regarding waste recycling or disposal.

Batteries and rechargeable batteries shall be recycled separately.



The separate collection and recycling of used products will help to conserve natural resources, and ensures that they are disposed of in a way that does not cause damage to the environment and nature.

9 Technical data

9.1 Hardware characteristics

Hydraulics			Meter DN size				
Nominal diameter		DN mm	15	20	25	40	50
		inch	1/2	3/4	1	1 1/2	2
Installation length		mm	165	165	190	300	350
Nominal pressure threaded ends	PN	bar	16	16	16	16	N/A
Nominal pressure flanges	PN	bar	25 / 40	25 / 40	25 / 40	25 / 40	25 / 40
Maximum medium temperature	T _{max}	°C	130, 180				
Maximum flow rate	Q _{max} ¹⁾	l/h	600	1500	3000	9000	30000
Continuous flow rate	Q_{cont}²⁾	l/h	400	1000	2000	6000	20000
Minimum flow rate	Q _{min}	l/h	20	40	75	225	750
Approx. starting flow rate		l/h	4	12	30	90	300
Max. permissible error of actual value ¹⁾	VZF II, VZO, DFM		±1.0 %	±1.0 %	±1.0 %	±1.0 %	±1.0 %
	VZFA II, VZOA		±0.5 %	±0.5 %	±0.5 %	±0.5 %	±0.5 %
	VZFA II linearized		±0.3 %	±0.3 %	±0.3 %	±0.3 %	±0.3 %
Repeatability			±0.1 %	±0.1 %	±0.1 %	±0.1 %	±0.1 %
Measuring chamber volume		cm ³	12	36	100	330	1200
Safety filter mesh size		mm	0.400	0.400	0.400	0.800	0.800
Weight with threaded ends ³⁾		kg	2.2	2.5	4.2	17.3	-
Weight with flanges PN 25		kg	3.8	4.5	7.5	20.3	41.0
Weight with flanges PN 40		kg	4.4	5.5	7.8	20.5	42.0

1) Manufacturer's specification, valid for the reference conditions as specified under reference conditions. Do not use this value for the design.

2) For burners and engines or motors, the fuel oil meter must be selected on the basis of the permanent flow rate. For higher viscosities, or if the meter is installed on the suction side, the pressure drop and any reduction in the measuring range must be taken into consideration.

3) Weight without couplings.

Mechanical display			Meter DN size				
Nominal diameter		DN mm	15	20	25	40	50
		inch	1/2	3/4	1	1 1/2	2
Smallest readable amount		l	0.01	0.1	0.1	0.1	1
Maximum registration capacity		m ³	1000	10000	10000	10000	100000
Registration time until overrun to zero at	Q _{min} (m ³)	h	2500	10000	5000	1667	5000

RV: Reed pulser with decadic pulse values

Ambient temperature	°C	-10 to +70				
Switching element		Reed contact				
Switching voltage max.	VDC/VAC	48				
Switching current max.	mA	50 (Ri 47Ω / 0.5 W)				
Static current		open contact				
Switching power max.	W	2				
On-time	%	50 +/- 10 %				
RV Reed		DN 15	DN 20	DN 25	DN 40	DN 50
	I/pulse	0.1	1	1	1	10
	I/pulse	1	-	-	10	100
Pulse value		see type plate				
Protection class		IP 65				
Connection		Permanent mounted cable, 3 m long, 2 x 0.14 mm ² cross section				

No Ex zone installation possible!**IN: Inductive pulser with decadic pulse values**

Supply voltage	VDC	5 - 25				
Nominal voltage	VDC	8.2 (Ri approx. 1 kΩ)				
Ambient temperature	°C	-10 to +70				
Protection class		IP 65				
Switching element		Slot initiator acc. to IEC 60947-5-6 (IN - NAMUR)				
Switching frequency	Hz	0 to 3000				
Residual ripple		<5 %				
Switching current	mA	≥3 (at 8.2 V, 1 kΩ)				
Static current zero	mA	≤1 (at 8.2 V, 1 kΩ)				
Pulse values for remote transmitter IN (NAMUR) inductive (IEC 60947-5-6)	I/pulse	DN 15	DN 20	DN 25	DN 40	DN 50
		0.01	0.01	0.1	0.1	1
Pulse frequency IN	Q ^{max}	Hz	16.667	41.667	8.333	25.000
	Q ^{min}	Hz	0.278	0.833	0.208	0.625
Connection		Connection cable min. 2 x 0.35 mm ² and 5.5 - 13 mm external cable diameter on plug (Prefabricated cable available)				

Pay attention to polarity when connecting the plus!**NOTICE**

The pulse value can be taken from the type plate.

10 Appendix

10.1 Dimensional drawings

All flow meters with threaded ends are according to ISO 228-1.

DN 15, 20, 25: with threaded ends

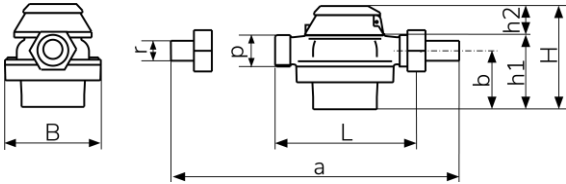

DN 40: with threaded ends

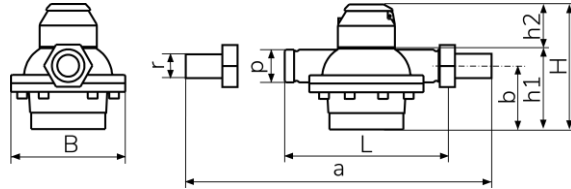

All flow meters with flanges are according to EN 1092-2, ASME B16.5 or JIS B2239.

DN 15, 20, 25: with flanged ends

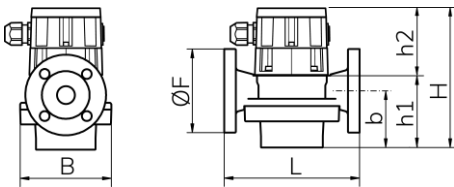

DN 40, 50: with flanged ends

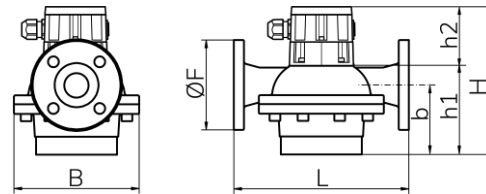

Nominal size	L	B	a*	Ø F	b	h1	p	r
DN 15	165	105	240	95	45	65	G 3/4"	G 1/2"
DN 20	165	105	260	105	54	74	G 1"	G 3/4"
DN 25	190	130	305	115	77	101	G 1 1/4"	G 1"
DN 40	300	210	435	150	116	153	G 2"	G 1 1/2"
DN 50	350	280	-	165	166	209	-	-

Dimensions in mm

a* = without gaskets (2x ~2 mm)

h2 is explained on next page

H = h1 + h2

10.2 Dimensions of display and pulse units

Module (h2)	VZF(A) II 15 - 50	VZO(A) 15 - 50			180 °C		
Max. temperature	130 / 180 °C	130 °C					
Pulsers	all	-	RV	IN	-	RV	IN
Dimensional drawing	1	2	3	6	5	4	7

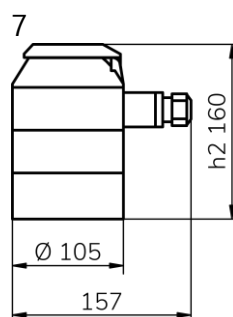
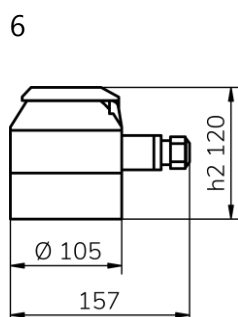
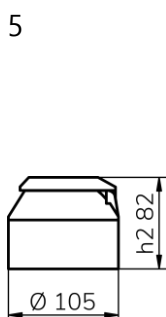
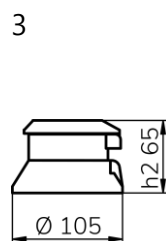
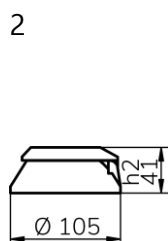
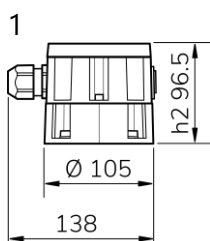

VZF II / VZFA II*



VZO/VZOA 15

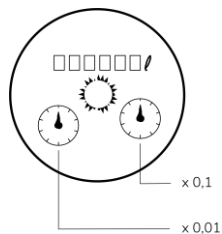

VZO/VZOA
20, 25, 40

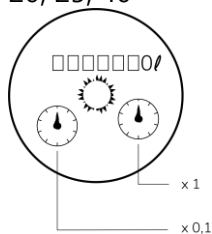

VZO/VZOA 50

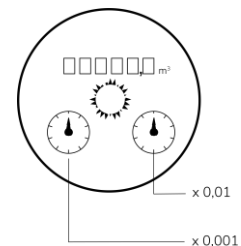

* VZF(A) type not described in this manual, just shown for completion of product.

11 Certificates

All the below mentioned certificates/approvals, can be found on our web site www.aquametro-oil-marine.com.

Class approvals		
Det Norske Veritas - German Lloyd	Norway – Germany	
Lloyds Register	United Kingdom	
RRR	Russian River Register	
RMRS	Russian Maritime Register of Shipping	
CCS	China Classification Society	

Versions with type approval and metrological CE approval

These versions of the CONTOIL[®] oil flow meter bear the number of the type test certificate in accordance with Directive 2014/32/EU and the metrological CE mark. This means that they can be used for CE-compliant measurements in accordance with local laws/regulations.



For details please request document «Versions with type approval and metrological CE approval and verification» (Art. No. 21469).



info@aquametro-oil-marine.com
www.aquametro-oil-marine.com

Aquametro Oil & Marine AG
CH-4106 Therwil, Switzerland
Phone +41 61 725 44 00

Aquametro Oil & Marine GmbH
DE-18119 Rostock, Germany
Phone +49 381 382 530 00